

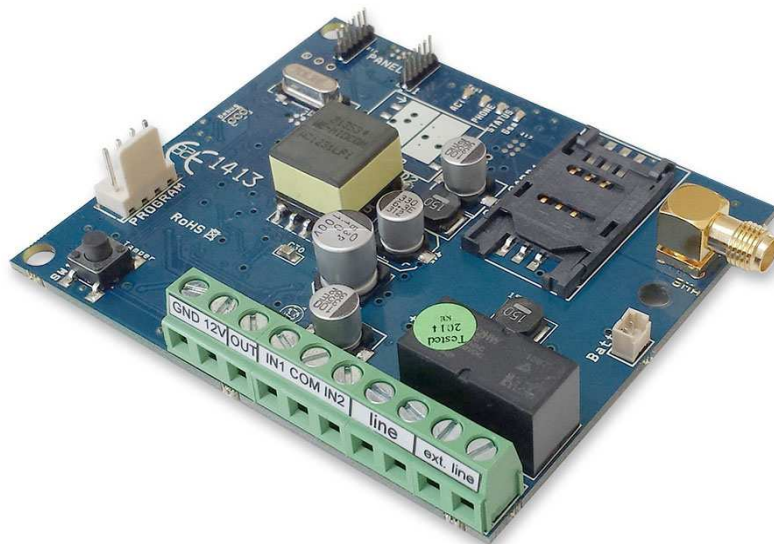

# ProLine GSM

PROFESSIONAL GSM/GPRS FORWARDER AND LINE SIMULATOR



INSTALLATIONAL AND USER'S GUIDE

## Table of contents

<b>Device description and function.....</b>	<b>3</b>
Figure 1: Device operation.....	4
<b>Module buildup.....</b>	<b>4</b>
Figure 2: Module buildup.....	4
Figure 3: Wiring diagram of terminal assembly.....	4
Figure 4: Inserting SIM card.....	4
<b>Installation guide.....</b>	<b>5</b>
Technical parameters.....	5
Installation steps.....	5
LED signals.....	6
<b>Connecting a module (PC).....</b>	<b>6</b>
Establishing connection using USB adapter.....	6
Manual installation of USB driver in 10 steps.....	6
Connection process using Bluetooth adapter.....	7
<b>Programming using the PC software.....</b>	<b>7</b>
Connection process to GSM/GPRS module.....	7
Program buildup.....	8
Checking module status.....	9
Switching off PIN code request on SIM card.....	9
Event Log Readout.....	10
Readout of GSM signal strength.....	10

## Device description and function

The GSM/GPRS device can be used as alarm center accessory as forwarder with 2 inputs and GSM/GPRS based line simulator. The module has 2 contact driven inputs and one Open Collector output.

The device can fully simulate a phone line. It emits a 48 V voltage with 72 V ringing voltage. The difference between simulated and existing, outer phone line voltage value (due to which the device can monitor its state) can be also adjusted if that differs from the amounts mentioned above (with 3V scales).

It can send notification to 8 phone numbers in SMS and/or voice message. The notification sending can be triggered by a signal arriving to any of the 2 inputs, by power failure and by sabotage. The notifications can be accompanied by an additional voice message that will be played when calling is answered. These recordings can be 8 seconds at most. The voice message can be accompanied with an identifying message that can be 15 seconds at most.

Output controlling with free call can be achieved from unlimited numbers. If you want to control with phone number identification you can store the numbers in the inner memory of the module (in this case 1,000 items) or in the SIM card inserted into the module. By using caller phone number identification the unauthorized triggering of the output can be forbidden.

The output can be controlled also with an SMS command that can even be a setting overriding command (ex.: in bistable switched off state we can control the output for 10 seconds). You can read in details of this command on the 21<sup>st</sup> page.

The module can store up to 16,000 events in which inputs and outputs states, power source restart, GSM network and module state related information and incoming and outgoing calls and SMSs are logged.

The tamper micro switch on the module can be used as a sabotage indicator with setting possibilities alike to inputs.

Holding down before powering on the module and releasing in 3 seconds after powering on functions as a "reset" that can reverts the module state back to its factory default when it is needed.

Implemented Anti Jammer System (AJS) protects from GSM jammers. The significant dropping of the GSM strength or a network disconnection initiates a prompt alarm. In these situations module tries to send notifications using remaining network possibilities. It can be set that by controlling the output even an external siren can be managed. This possibility is especially useful if we would like to fob the person who committed the sabotage.

GSM module is able to monitor the available phone line. Using this feature the used channel can be set when transmitting. If the GSM or PSTN network connection fails the device switches to the other channel and delivers the signal to remote surveillance or towards end-users.

Besides the line emulation the device is able to translate the Contact ID codes arriving from alarm centers to simpler text that is easier to understand also by end user and forwards them in SMS to the 8 saved phone numbers. The text of the SMS and chosen phone numbers might be modified in every code.

Besides continuous voltage monitoring the module checks also the GSM signal strength. These data can be readout and these can be charted divided into hours on a graph by the programming software.

By using extension modules (EXP Relay, EXP Relay3) the device can have additional outputs. These outputs can be also configured independently.

The module can be programmed by SMS command, PC or by Android based mobile phone.

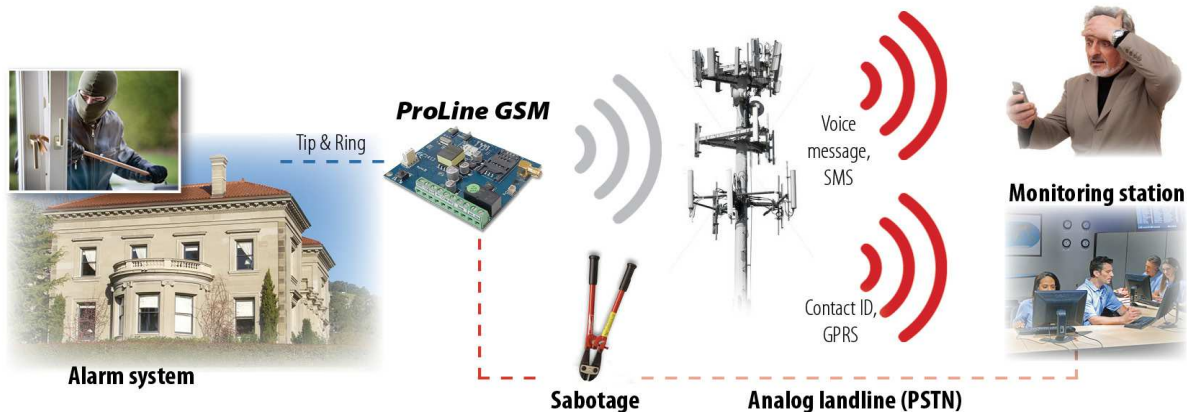

Figure 1: Device operation

# Module buildup

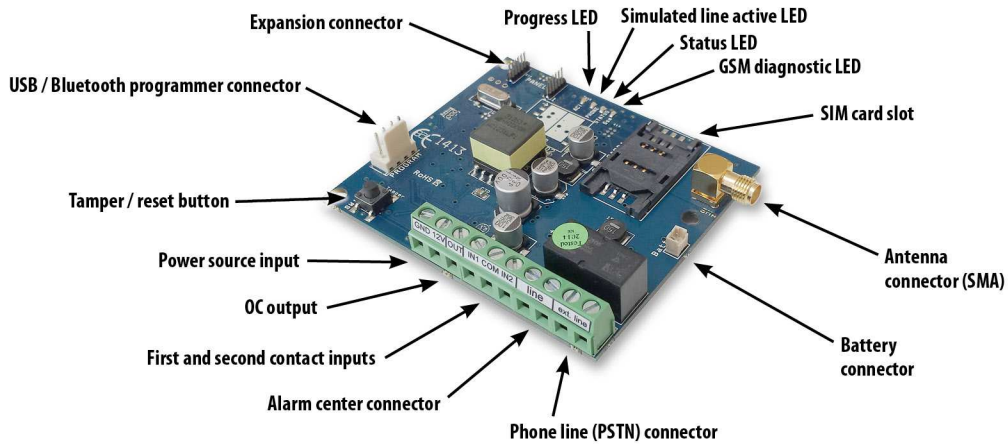

Figure 2: Module buildup

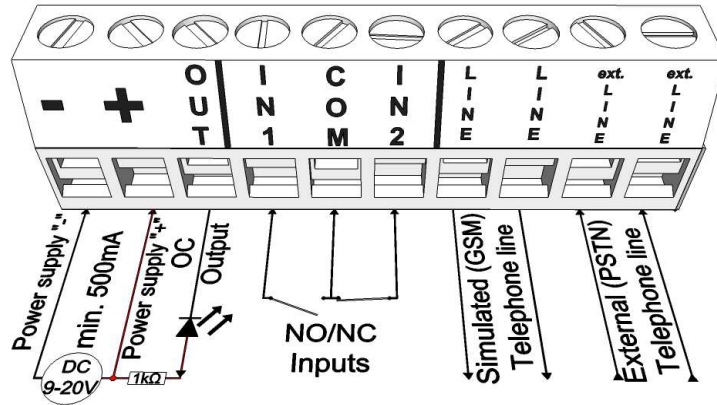

Figure 3: Wiring diagram of terminal assembly

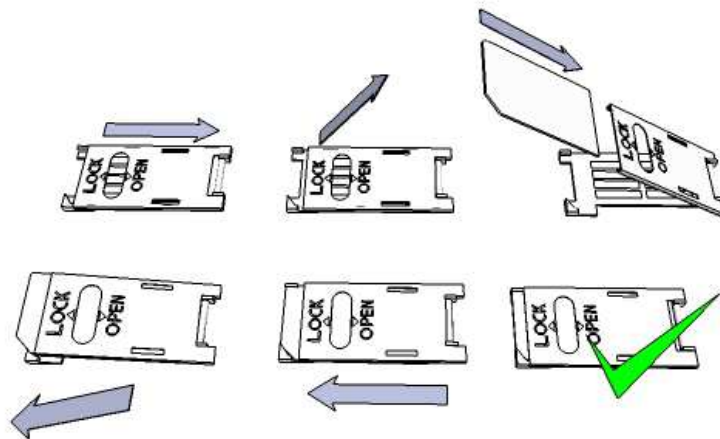

Figure 4: Inserting SIM card

# Installation guide

## Technical parameters

- Power voltage: 9-20 VDC
- Standby power drain: 80 mA
- Maximum power drain: 1000 mA
- OC output load: max. 30V / 400 mA
- GSM module type: SIMCOM 900
- GSM frequencies: GSM 850 / EGSM 900 / DCS 1800 / PCS 1900 (Multi- Band)
- SIM card usage: provider free GSM module
- GSM antenna type: with SMA connector (bundled)
- Dimensions: 82 x 69 x 25 mm, packed: 132 x 128 x 32 mm
- Operation temperature: -20°C - +50°C

## Installation steps

1. Carry out a signal strength check with your mobile phone. Sometimes occurs there is no sufficient signal strength at the commissioning site. In this case it is recommended to change the module position prior to installation. Do not install the device to places where strong electromagnetic waves might occur, ex. next to electric motors or alarm transformers.  
Do not install in watery places or to places with great humidity.
2. Connecting the antenna: antenna can be secured with an SMA connector. If you are reading low signal strength use an antenna with higher gain. Signal strength grow can also be achieved by repositioning the antenna.  
**Do not position the antenna under various metal covers of devices as those might significantly ruin the signal strength.**
3. **You should opt out the PIN number request, voicemail and call notification.**  
Sometimes new SIM cards must be activated (usually an outgoing call has to be made).
4. Check the validity of the card. If you have a prepaid card check its balance and its usage possibilities (ex. only calls). It is practical to check the satisfying operation of a SIM card in a cell phone prior of insertion into a module. Number identification has to be checked at caller and also when on the called side. This feature at certain service providers must be enabled formerly.
5. Insert the SIM card in the SIM card slot on the module.
6. Connectors have to be connected according to the wiring diagram. If you are using OC output mind the correct wiring of the relay protecting diode.
7. If you are using OC relay be cautious especially in avoiding high voltage electric hazard. A proper contact protection must be established. If you lack enough experience seek for professional help.
8. Check if the power supply performance will be sufficient for the module. Mind the polarity. If wiring is reversed the module will not operate or might be damaged.
9. After these the device can be powered.
10. If you have purchased a battery connect it to the device. Use only battery purchased from us for auxiliary powering of the device!
11. After connecting the voltage supply the red LED is lighted indicating the device establishing connection with the GSM system (this can be 1 minute utmost).
12. If red LED goes off and green LED is blinking module is online and connected to network. The blinking number(s) indicates GSM signal strength.

**For programming the power supply must be connected!**

## LED signals

Signals give essential information of the module, about GSM signal strength and of the actual error codes. By blinking we mean flashes between two longer pauses.

- Constant blinking of the Phone LED (red) means the alarm center connected to the module receives the phone line and starts the calling process. The same LED blinks means reception of DTMF sounds and indicates also the call process.
- A STATUS LED (green) gives feedback of signal strength based on the chart below:

Flashes	Signal quality
1	Bad
2	
3	Decent
4	Good
5	Excellent
LED lighted	GSM connection rejected

- An ACT LED (red) lit means the initiation process at startup. At this phase module performs the initial checkings. Under operation this notion indicates some kind of event (SMS or voice call).
- If the red and green LED are lighted simultaneously it tries to communicate an error that can be identified with the chart below:

Flashes	Error code
1	Initializing
2	Bad GSM module
3	SIM card not inserted
4	SIM card locked with PIN code
10	Modem mode

- Blinking of red and green LED means the "reset" button was used and default settings were loaded.

## Connecting a module (PC)

### Establishing connection using *USB adapter*

1. Connect the USB adapter to the *Program* labeled slot of the module.
2. The USB adapter is able to provide the sufficient power for the GSM module.
3. Attach the USB connector of the adapter to an extension cable and plug into any PC USB port
4. **WARNING! If you are using Windows XP operation system** the system offers an automatic driver installation. IMPORTANT, do not use the offered driver but carry on with the installation of the **USB program driver**.

### Manual installation of USB driver in 10 steps

- ✓ Get the needed drivers from our website or if you have an USB KIT from the "USB driver" folder of the CD.
- ✓ Use the 32 or 64 bit driver which is compatible with your system
- ✓ Using Windows operation system you will find this information under Control Panel → System (at Windows XP the "x64 Edition" will only appear if the system is 64 bit)
- ✓ Connect the USB programmer to the PC
- ✓ opt out the automatic installation possibility offered by the system
- ✓ open the **Device Manager** window from Control Panel → System → Hardware.
- ✓ In this window search for Unknown device under other devices (which is in this case the programmer, later will be USB Serial port). If you do not find such device click the "Scan

- hardware changes" button on the upper menu part.
  - ✓ Double click on the unknown device for device properties
  - ✓ Start the update driver function
  - ✓ In the setup window caused by this choose the manual driver installation path then choose the folder 32 or 64 bit of the driver.
  - ✓ Click on Next and start the installation
5. Open the Device Manager using the following path: System → Properties → Hardware tab → Device Manager
  6. Search for USB Serial port (COM...) device under Ports
    - If driver has to be reinstalled click here on the device then on the driver uninstall. After this follow the steps described above.
  7. Open the programming software
  8. You have to set the value appearing in brackets [USB Serial port (COM...)] in the programming software.
  9. If this was successful after connecting the module its name will appear next to **Start** button.

### Connection process using *Bluetooth* adapter

1. Connect the Bluetooth adapter to the GSM module and switch it on.
2. On your programming device (PC or Android based mobile phone) switch on the Bluetooth connection
3. Search for programmer with your Bluetooth enabled device.
4. After finding the adapter you can pair your PC/smart phone with the adapter by using the default **1234** code. After pairing process you will find the programmer as GSM Programmer.
5. Search for the COM port identification number of the connection (usually under *Properties* -> *Hardware* tab)
6. Set the port number also in your programming software (PC) or choose the automatic port finding option.
7. Establish a connection with the GSM module.

***Under Windows 8 operating system the programming software has to be started in "Windows XP SP2/SP3" compatibility mode (Right click on the program shortcut → Properties → Compatibility).***

In every case if the connection was successfully established you will see the connected module name in the programming software next to Start button and the green LED starts to blink on the programmer.

**If you have a connection established between the adapter and your PC or mobile phone you can start the module configuration.**

- **By clicking the Start button after connection module settings readout starts**
- **By clicking the Start/Default config button the module will be reverted to factory settings (after confirmation)**
- **Using the Android application settings readout happens after connection was established**

## Programming using the PC software

- if you have chosen configuration by PC you can use our software that is freely down loadable from our website or you can find it on the installation CD in the USB KIT.
- The program is running automatically, no installation needed
- Compatible with Windows XP, 7 and 8 operating system
- Make sure you always use the latest software!
- If newer software is out the module should be updated prior to the first configuration.

### Connection process to GSM/GPRS module

- Pick which connection (USB or Bluetooth) you would like to use for module programming.
- In the list under the language selection part (COM1 in the picture) you can select the port through which you would like to communicate with the module programmer. You can find this value (under Windows operation system) at Device manager → COM port by selecting the connected programmer. If you can not decide you might let the program to search for it by pressing the ***automatic COM port finding***. The automatic COM port search might take several minutes.

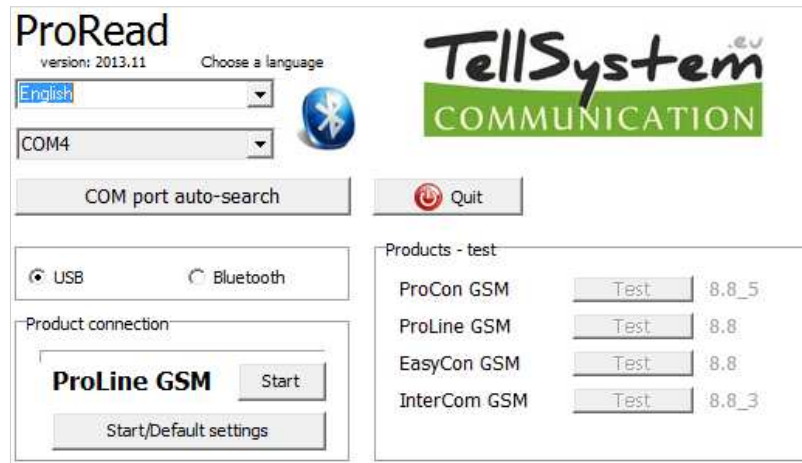

- If the connection was successful you will see under the Product connection tab the name of the module.
- Clicking the **Start** button the software makes connection to the module and reads out the module settings.
- By clicking the **Start/Default settings** button the module will be set back to default values after the connection was established. (Before the operation the software asks for confirmation if this feature has not been switched off before).
- If you do not want to connect a module yet just to inspect the settings options you can select the *Products-test* window where you can freely make a module properties selection and also module preprogramming.

### Program buildup



- Upper menu items:
  - *Service*: Basic menu items needed for module maintenance (ex. checking module status, event log readout, opting out SIM PIN code request, firmware update)
  - *File*: Saving and loading settings
  - *Manuals*: viewing the wiring diagram
  - *Settings*: setting window size, turning off confirmation questions
  - *Language*: language selection(available languages: English, Hungarian, Italian, German, Slovak, Slovenian, Dutch, bohemian, Finn, Romanian)
  - *Contact*: contacts with e-mail addresses and phone numbers
  - *GSM*: GSM chip (SIM900 chip) and peripheral PSTN line monitoring reversion back to factory default

settings (in case of fault), displaying GSM information and you can set here the SMS number of the carrier

- You can reach the various settings possibilities by clicking the appropriate tab
- On the main page (**Basic data** tab) clicking the Time synchronization button makes the module to adjust its time to the clock of the PC.

After the device connected to the GSM network it will synchronize through the carrier automatically (if the network supports this service).

- The **Read** and **Send** buttons at the bottom are for readout and edit of module configuration. These buttons are accessible everywhere except the **Caller ID** tab.

You should send data to the module with the **Send** button after every significant modification.

Before sending your settings make sure those will not trigger an unexpected alert. You should readout the actual module state beforehand (**Service** tab).

- **With the Restart button you can restart the module. After monitoring it is suggested to restart the module.**
- In the lower menu line you can be informed of the followings:
  - Communication port number
  - GSM module name
  - Firmware version number
  - Notification related to the actual software operation
  - ProRead version number

### Checking module status

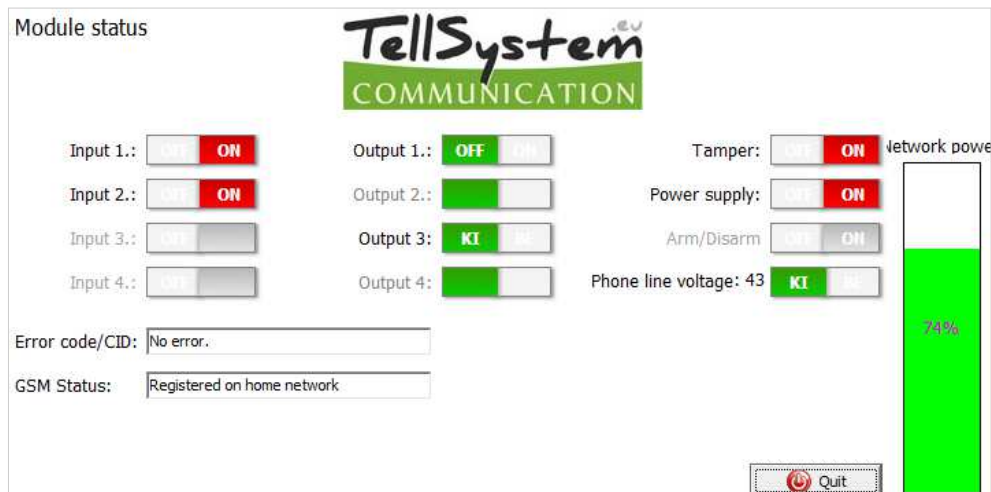

You can see the status by pressing the **Service** → **Show module status** button.

By the module status query you will be informed of the followings:

- input statuses
- output statuses
- Tamper notification
- power supply failure indication
- phone line voltage
- displaying error/event codes if any (ex. SIM card not inserted, SIM card locked by PIN code)
- checking Contact ID sending (ex. to remote surveillance) process (ex. handshake status)
- GSM connection status (ex. connected to the network, roaming, no connection, connection refused)
- actual GSM signal strength (refreshed in seconds)

### Switching off PIN code request on SIM card

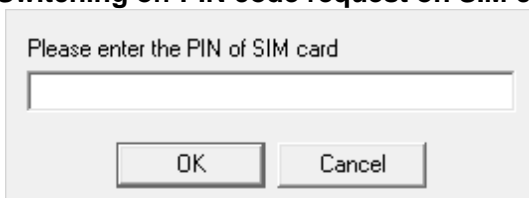

Before inserting SIM card in the module the **PIN code request have to be switched off**

- If you have not done yet then you can switch it off at **Service** → **Switch off PIN code request.**

- You will see the window below, where you can input the code and its request will be switched off by the software.

## Event Log Readout

Event Log					
<span>Read event log</span> <span>Read stop</span> <span>Export Excel</span> <span>Open CSV</span> <span>Quit</span>					
EVENT	DATE	GSM 0-31	GSM Network	Note / parameters	
132	SLIC RESTART	2000.0.1.0.1. 00:01:50	25	Connected	
133	GSM logged	2000.0.1.0.1. 00:00:37	25	Connected	IMEI:01289600222062 SW:08.7
134	Microcontroller START/RE	2011.0.1.0.1. 00:00:02	0	Not connected	
135	GSM logged	2013.0.1.12. 14:01:58	23	Connected	IMEI:01289600222062 SW:08.7
136	Microcontroller START/RE	2011.0.1.0.1. 00:00:02	0	Not connected	
137	GSM logged	2000.0.1.0.1. 00:00:41	25	Connected	IMEI:01289600222062 SW:08.7
138	Microcontroller START/RE	2011.0.1.0.1. 00:00:02	0	Not connected	
139	OUT call (successful)	2000.0.1.0.1. 03:41:42	3	Connected	3292005646
140	Incoming SMS	2000.0.1.0.1. 03:40:39	11	Connected	3292005646/Sono di nuovo raggiungibile dalle
141	SLIC RESTART	2000.0.1.0.1. 03:40:22	11	Connected	
142	OUT call (successful)	2000.0.1.0.1. 03:39:50	9	Connected	3292005646
143	SLIC RESTART	2000.0.1.0.1. 03:38:31	18	Connected	
144	OUT call (successful)	2000.0.1.0.1. 03:38:03	16	Connected	3292005646
145	OUT call (successful)	2000.0.1.0.1. 03:37:22	16	Connected	3292005646
146	SLIC RESTART	2000.0.1.0.1. 03:34:26	9	Connected	
147	OUT call (successful)	2000.0.1.0.1. 03:34:01	14	Connected	3292005646
148	Incoming SMS	2000.0.1.0.1. 03:34:01	14	Connected	3292005646/Sono di nuovo contattabile dalle
149	SLIC RESTART	2000.0.1.0.1. 03:33:55	14	Connected	
150	OUT call (successful)	2000.0.1.0.1. 03:33:33	14	Connected	3292005646
151	SLIC RESTART	2000.0.1.0.1. 03:31:06	18	Connected	
152	OUT call (successful)	2000.0.1.0.1. 03:30:55	18	Connected	3292005646
153	OUT call (successful)	2000.0.1.0.1. 03:30:46	13	Connected	3292005646
154	SLIC RESTART	2000.0.1.0.1. 03:29:28	18	Connected	
155	OUT call (successful)	2000.0.1.0.1. 03:29:06	16	Connected	3292005646
156	SLIC RESTART	2000.0.1.0.1. 03:27:40	17	Connected	
157	OUT call (successful)	2000.0.1.0.1. 03:27:22	14	Connected	3292005646
158	SLIC RESTART	2000.0.1.0.1. 03:25:01	11	Connected	
159	OUT call (successful)	2000.0.1.0.1. 03:24:42	14	Connected	3292005646
160	SLIC RESTART	2000.0.1.0.1. 03:22:22	17	Connected	
161	OUT call (successful)	2000.0.1.0.1. 03:22:01	12	Connected	3292005646
162	OUT call (successful)	2000.0.1.0.1. 03:21:24	7	Connected	3292005646
163	Incoming SMS	2000.0.1.0.1. 03:20:39	12	Connected	3292005646/Sono di nuovo contattabile dalle
164	SLIC RESTART	2000.0.1.0.1. 03:20:33	12	Connected	
165	OUT call (successful)	2000.0.1.0.1. 03:20:12	17	Connected	3292005646

The event log can be viewed with **Service** → **Log readout** button:

- The GSM module can store up to 16,000 events in FILO (first in-last out) mode
- In the **Event** column there are short event information
- In the **Date** column event dates are stored (divided in year, month, day, minute, second). IMPORTANT! Date will be accurate if the clock of the module is synchronized with a PC or with a GSM system. The latter one is automatically completed when the module connects to the carrier network.
- The **GSM 0-31** indicates the signal strength at the time of creation. 31 is the highest value and 0 means no connection
- In the **Comment/parameter** column notification related extra information are stored.
- Initially the chart is empty; the readout can be commenced by pressing the **Event List Readout** button.
- The newest data will appear at the top of the list followed by older entries as you go down the chart.
- If the whole chart readout is not necessary you can stop the process with the **Readout stop** button.
- Read out list can be exported from the software in "csv" (Excel) chart so later it can easily be sent and stored for later examination.

## Readout of GSM signal strength

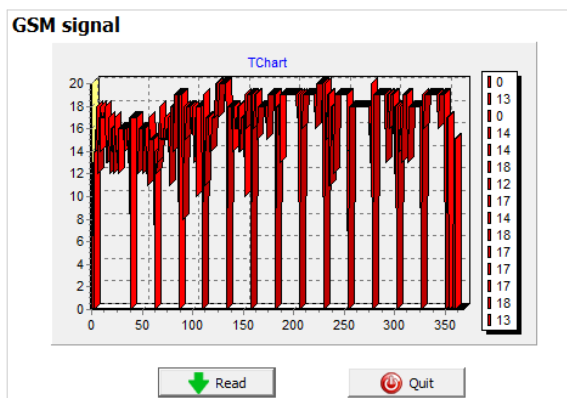

Regarding the GSM status a graph can be displayed (see the picture at left)

- The path of showing GSM signal strength is available by the **Service** → **Show GSM signal strength** button
- Values are read by pressing the **Read** button
- Signal strength fluctuations are divided by hours. You can track the passed hours backwards starting from right to left.
- In the diagram vertical scale is calibrated from 0 to 31. 31 mean the best signal strength.
- Size of the chart can be altered with a left click.

## Fill out basic data

**i** Basic data

Client name:

Username:

GSM phone number:

Type of alarm center:

Type of GSM module:

Date of installation:

Important data of the installed GSM module can be set. Besides the client name and commissioning address the phone number of the SIM card inserted in the module and also the type of the attached alarm center can be set.

- Data inserted are stored in the module
- Stored data can be useful later during servicing.

## Saving phone numbers for notification

**Phone number settings**

Add phone numbers for notification:

Number 1.:

Number 2.:

Number 3.:

Number 4.:

Number 5.:

Number 6.:

Number 7.:

Number 8.:

In the phone number tab you can set those phone numbers to which you would like to send SMSs and/or voice messages. **Numbers given in this section must be in international format to ensure safe operation.**

(Ex.:+444555123411 or 0044555123411)

- For notification 8 phone numbers can be set at most.
- You can set these numbers in the following program sections.
- This list can be edited also by SMS with the "TELx= phone number" command, where 'x' represents the ordinal number of the selected phone number for edition. (Example: 1234TEL1=+44555123411, 1234TEL2=+44555123411) You can read further information on **SMS commands** on **page 20**.

## Saving controlling phone numbers

**Phone number identification**

Own memory | SIM card number

	Number
1	
2	
3	
4	
5	
6	
7	
8	
9	
10	
11	

Control 1st output

Control 2nd output

Control 3rd output

Control 4th output

Arm/Disarm

Do not request for security code in voice menu

Direct DTMF control Phone

Open form file

Save to file

Read numbers from memory

Write numbers to memory

Search

- At the incoming phone numbers section you can set controlling numbers that can control the outputs.
- Phone numbers can be stored in the memory of the module (1,000 pcs). Moreover additional phone numbers can be stored in the SIM card.
- By using inner memory the module will be indifferent to the SIM card memory.
- Always read out the memory before editing the list with the **Readout numbers from memory** button. For saving use the **Save numbers to memory** button.
- **Given numbers must be in international format.** Due to number length using "+" is suggested (ex.: +44555123411).
- Saving, editing and opening of stored numbers are also possible (from .csv file).
- Incoming numbers can be associated with specific outputs.
- As a new function the DTMF controlling was implemented thus outputs can be controlled with cell phone buttons

(1, 2, 3, 4). Module activation and deactivation can also be achieved through DTMF command (\*).

- The list can be modified also by **SMS command**: "ADD=phone number" (addition) and "DEL=phone number" (delete). Example: 1234ADD=+44555123411, 1234DEL=+ 44555123411  
You can find additional information on SMS command on **page 20**.

## Input configuration

GSM module has "dry" input contacts. Before viewing settings please inspect the pictures below that shows input connecting variations. You can set the inputs with different settings.

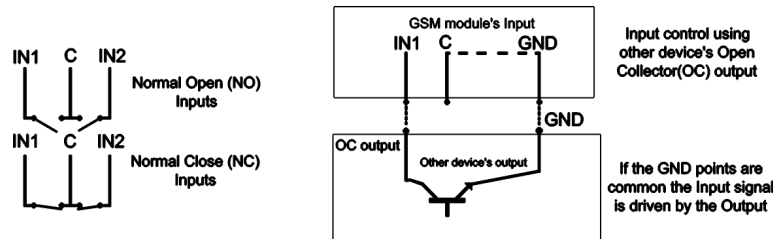

Picture 5: Normal open (NO) and Normal Close (NC) wiring

You can set on this tab a short or rupture caused alarm to which phone numbers will send notification via SMS or voice message. It is possible to send both notifications to the same phone number.

- On the *Input type* tab you can set how the input should operate:
  - 00/Not used: not used inputs can be switched off so no jamming signals can be received.
  - 01/24h normal input: 24/7, constant, input indifferent to activation status
  - (02/Reserved: option reserved for later upgrades)
  - 03/Autonomous input: this input will send alert only if the module is activated.
  - 04/delayed autonomous input: in activated state this input starts a countdown (can be set on the "Other" tab) while you have chance to deactivate.
  - 05/Switch on/off: switching the module on or off. This can be controlled with continuous contact (ex key switch). Normally closed state is suggested so any wire rupture in circuit will trigger an alarm.
- **SMS notification** can be sent if the inputs **revert back** to normal state.
- If siren sound is picked as alarm sound voice call duration will be 25 seconds. If also the voice message option is chosen the duration will be 5 seconds.
- At **voice message** sending **prerecorded** or custom sound can be sent via voice call (**Sounds** tab).
- **Remote surveillance** can also be notified of the input state change.
- You can set a **no pickup mode** when the module will not try to call again if it realized a successful call indifferent if the call was answered or not
- **At the first input we can set to send an alarm event when it is switched on for the first time.** With these settings module will initiate an alarm event at once. This setting is suggested when we want the power on to

trigger an alarm event.

- You can set the text of the SMS in the SMS text field that can be maximum 32 characters long. Input modification can be made via SMS commands with the following parameters:

**1234INPUT1=tnneeeeeeee**

t:0 → switched off, 1 → 24h normal, 2 → reserve, 3 → alarm normal 4 → alarm delayed, nn → NO or NC eeeeeeee:

Other parameters: 1.e=1 → Sending SMS when reverting back to the original position 2.e=0 → always 0 3.e=1 → siren sound 4.e=1 → Voice message 5.e=1 → remote surveillance 6.e=1 → no need to pick up when called 7.e=1 → DTMF acknowledge (#) 8.e=0 → always 0

You can read more information of **SMS commands** on **page 20**.

## Voice message settings

In the **Sounds** menu a specific alert can be associated with a specific recorded voice message.

- The function of the **identifying message** is to identify the module (ex. address, asset name) if we receive messages from several modules.
- If you click the red record button you can record your own voice with a microphone attached to your PC. This can be maximum 8 seconds and up to 15 seconds is available for identifying message.
- During voice recording it records as default from the microphone. Sometimes it needs to be adjusted (ex. signal level, amplify) for the optimal quality.
- By clicking the Play button you can listen to your recording.
- If you would like to upload a prerecorded sound file than you can open a file upload window by clicking the appropriate text box near the event defining text.

The sound file format has to be identical with the format used on GSM networks. It has to be 8 kHz sampling rate, 8 bit, mono PCM modulated "wav" file.

When you have the desired sound it can be uploaded to the module by clicking the **Upload** button.

## Adjusting outputs

In the **Output** window the output settings can be changed. Output type can be **monostable** namely one stasured, (switches off for the given period than reverts back to the original status), or **bistable** namely two stasured (it will revert back to original state only after a new controlling).

- Regarding monostable operation switch time can be set in seconds (max 65,000) or minutes.
- By choosing of **SMS fault** the output is controlled if the GSM provider failed to send the SMS message.
- If you choose **GSM fault** as output controll type the output is controlled when the GSM signal is lost untill the GSM reconnection successfull.
- Regarding output controlling it can be set if you want to control by incoming

- call or (in case of 24/7 active input) it should be controlled by an alarm event.
- When controlling with caller numbers you can choose between unidentified or identified phone number controlling.
- Anybody can control the output with unidentified phone number controlling if the phone number of the SIM card is known.
- If the phone number identification is selected controlling for a number not in the list will be rejected by the module. This greatly improves safety of the device connected to output from
- **Further outputs are available for our Pro series by EXP Relay or EXP Relay3 expansion panels. The EXP Relay options can be set on the Other tab. You will find additional information on page 20.**



**EXP RELAY**

- EXP Relay has 1 more, EXP Relay3 provides 3 additional outputs to the modules. Thus using EXP Relay3 you can have a GSM module with 4 outputs.
- **You can use only one expansion panel at once!** Expansion panels go into the **Panel** labeled socket of the module.
- Both expansions has low-tension relayed output switch.
- EXP Relay includes NO/NC relay, EXP Relay3 can be adjusted with a plastic jumper between NO or NC output modes.

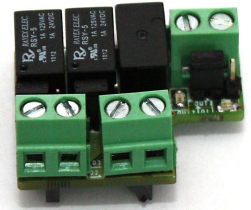

**EXP RELAY3**

Output programming can be achieved by sending the following message:

1234OUTx→ Selectable parameters: ON, OFF, RUN or switching for a given period (defined in 5 characters)

example: 1234OUT1=00003 → Controlling the output for 3 seconds.

**For additional SMS command information see page 20.**

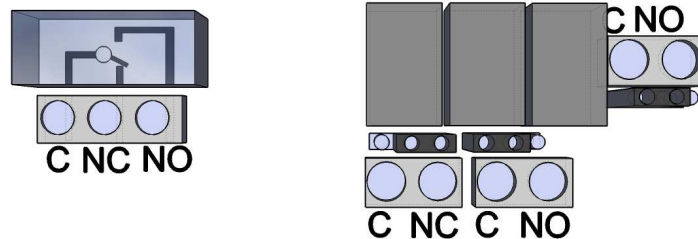

**Figure 6: EXP Relay and EXP Relay3**

### Tamper settings

**Settings of Tamper**

Select phone number(s) to send SMS:

<input type="checkbox"/> +445551234	<input type="checkbox"/> Phone5
<input type="checkbox"/> +445552345	<input type="checkbox"/> Phone6
<input type="checkbox"/> Phone3	<input type="checkbox"/> Phone7
<input type="checkbox"/> Phone4	<input type="checkbox"/> Phone8

Select phone number(s) to call:

<input type="checkbox"/> +445551234	<input type="checkbox"/> Phone5
<input type="checkbox"/> +445552345	<input type="checkbox"/> Phone6
<input type="checkbox"/> Phone3	<input type="checkbox"/> Phone7
<input type="checkbox"/> Phone4	<input type="checkbox"/> Phone8

Type of input:  
01/ 24h normal input

Normal Close  
 Normal Open

SMS/Call when input set back  
 Siren in the phone Call  
 Voice message  
 Monitoring station notification  
 When a call is not to be taken!  
 DTMF acknowledge during call (#)

SMS text:  
Tamper alarm

The Tamper button is a microswitch on the device. In the Pro line protects the module and its case from tampering. Its settings do not differ from any other input configuration.

- A Tamper switch should be interpreted as normally closed. When this is removed alarm will be triggered.
- By pushing the button before switch on and releasing after 3 seconds resets the GSM device to factory default settings.

### Power supply monitoring setup

The GSM device is able to monitor its own power source and it can send notification if there is a failure.

- Under the **Power monitor** tab the trigger voltage level can be set. Below this the module sends an alert.
- Our modules from Pro series have battery connection socket where the Pro Battery can be connected.
- **IMPORTANT!** Modules without auxiliary power supply will switch off if the main power supply is flat.
- Additional function settings resemble with input settings.

### Life signal setup

By life sign sending the user can be sure about the flawless operation of the system.

- The life signal sending periods can be set in days and also the hour can be specified.
- **To enable this function the Send life signal option must be selected!**
- It is also important the day of the first sign can be scheduled not to arrive on the day of setup.

- You can modify life sign notification with the following command: 1234LIFETEST=cccsstttttt  
 ccc → sending cycle in days (ex.: 007 days)  
 ss → when of the chosen day it should send the message  
 tttttt → to which number it should send the message (ex.:00100000 → sends message to the 3<sup>rd</sup> telephone number). You can read more of **SMS commands** on **page 20**.

### Anti Jammer System (AJS) settings

By using a GSM jamming device the GSM module can be sabotaged by suppressing heavily the signal strength of the network or by its complete suspension. The Anti Jammer System (AJS) is monitoring the signal strength of the network.

- You can set which output you would like promptly to control when there is an Anti Jammer System event. It will control a device connected to the output (ex. auxiliary siren).
- the sending of SMS/voice call can be completed only if there is still a connection with the network. If connection is lost notification will be sent after the connection is available.

### Remote surveillance settings (voice call)

Remote surveillance notification can be used side by side with the SMS and voice message notification. This feature needs more than 50% of signal strength.

- First remote surveillance will be notified than remaining notifications will be processed.
- Two remote surveillance numbers can be set. If there is a connection failure with the first number it will call the second phone number.
- Client code is decided by the remote surveillance. You can use only your own code.
- The communication with the remote surveillance can be improved by changing the signal level of the module transceiver.

First example: if the sent code cannot be interpreted then the signal level of the Sender has to be adjusted

Second example: during the handshake if the module does not receives accurately signal reply from monitoring station the level of Receiver has to be modified

- Change the default settings only in case when this is required by the available signal strength or remote surveillance distinctives.

### Using your own signal (ContactID) codes

- The module can forward also self generated signals (ex. signals to inputs, power source failure) to remote surveillance.
- Contact ID and Zone codes can also be modified.
- Notification can be revised under the Servicing -> Module state display tab. Here in the error code window the sending of actual Contact ID is displayed.
- If messages sent are not clear signal strength and module antenna position must be checked.
- **The connected antenna should be always away from the module and any other electric device or cable!**

Settings of monitoring station

Own generated codes (CID) | Voice call | GPRS

	CID	ZONE
Input 1.:	130	001
Input 2.:	130	002
Tamper:	137	001
Ext. power monitor:	302	001
Life signal:	602	<input checked="" type="checkbox"/> Life signal
Arm/Disarm:	401	<input checked="" type="checkbox"/> Arm/Disarm

Life signal period [min.]: 1440

### GPRS settings

Settings of monitoring station

Own generated codes (CID) | Voice call | GPRS

Protocol: ENIGMA | UDP

APN: net

Username: username

Password: passwor

DNS1: AUTO

DNS2: AUTO

Key: OFF

Server address: 192.168.1.1 | PORT: 1234

Test period in min: 2

Contact ID code: 603

Customer ID:  Setted customer ID |  Obtain from TIP/RING

Sending the GSM module internal alarm

Contact ID logging to the event list

Server1 | Server1\_back | Server2 | Server2\_back

On this page the carrying protocol can be set for data transmission. We suggest TCP usage only in justified situations, the UDP communication is much quicker.

- In the latter case no need for user and password input.
- Currently compatible communication protocols: ENIGMA and SIA IP
- At server address IP address and Domain name (this needs DNS server configuration) is also accepted.
- Backup servers can also be used to ensure communication.

- Frequency of test message sending can be set. A special Contact ID code can also be assigned to it.
- At the GPRS client code you can input previously set codes (on the remote surveillance tab) or allow the acquired code from line by using Tip/Ring.
- You can also enable own code sending (inputs, power supply monitor, tamper, life sign). Codes associated with these can be set at the remote surveillance tab.
- For using GPRS connection when using remote surveillance center has to dial **4444** or **4445 (4444- server 1, 4445 – server 2)**

### Line simulator settings

- By choosing line simulation mode the GSM network or the analogue line connected to EXT.LINE points can be selected for the module to use as default when transmitting. When there is an error module is able to switch to the other transmission channel (except when mode is set to *Only GSM*).
- By adjusting the line voltage the telephone line (connected to **EXT.LINE**) voltage monitoring value can be set. Module checks status of the telephone line based on this value.

Settings of Line simulator

Line simulator operation mode: Only GSM

Line voltage [V]: 48

All incoming call directed to LINE

PSTN receiver strenght (Rx): 15

PSTN transmitter strenght (Tx): 20

DTMF receiver strenght (Rx): 12

DTMF transmitter strenght (Tx): 35

PSTN send

- Incoming calls arriving to module can be automatically forwarded to the device connected to LINE. With this feature remote calibration of alarm centers can be carried out (if center facilitates with this possibility).
- PSTN and DTMF sound transceiver amplifier values should be changed only for good reasons; if the connection with remote surveillance is weak. Usually default values (at good signal strength) are the optimal.
- PSTN and DTMF sound transceiver amplifier values should be changed only for good reasons; if the connection with remote surveillance is weak. Usually default values (at good signal strength) are the optimal.
- Overdrive can be avoided by lowering the sending and receiving signal level amplification.
- DTMF sound amplification should be changed when problem arise during the connection or handshake with remote surveillance (failing connection during handshake, sent code cannot be interpreted)

### CID/SMS conversion settings

Incoming Contact ID codes can be converted to SMS texts by the module and it can forward those to selected phone numbers.

- Incoming events will be forwarded as SMSs only to the selected phone numbers. Incoming events will be forwarded as SMSs only to the selected phone numbers.
  - Event text and zone name can be modified for better interpretation.
  - After SMS sent also a call notification can be set.
  - Both code tables should be filled out at the very first programming.
  - Always select the cell of the event prior selecting phone numbers.
- To use this function with an alarm center it has to dial the number 5555. If every message should go the same number alarm center has to dial 5555 + telephone number (ex.: 5555+36204441234).

### Other setting options

Other module settings can be found here. For easier manageability we have divided these parameters into categories: General, voice call and SMS.

On the **General** tab you can access the followings:

- **Extension card selection** (at the moment output expander is available)
- Using **entry postponing** on delayed input (SMS command: 1234SMSTEXT16=sms text\*)
- Save SMS that will be sent when the alarm reverts back to original state.
- Modify the **PC security code** (If the value is set to null the security code checking is disabled).
- **Output state saving** to memory. At a restart it will read out the output state from here.
- **Input sensitivity** (when switched off: 10 ms, low: 100 ms, normal: 400 ms, average: 1 sec, high: 5 sec)

On the **Voice call** tab you can access the followings:

Ring Time [sec]: 30  
 Max number of redials: 50  
 Talking time: 90  
 Circular calling

- Voice call parameters: set **ringing and talking time** and number of **call attempts**.  
(SMS command: 1234RINGTIME=030 → ringing for 30 seconds)
- By selecting **circular calls** every related phone number has to confirm the alarm notification.

On the **SMS** tab you can access the followings:

SMS redirection: Phone1  
 SMS security code: 1234  
 Daily SMS limit: 30 If = 255, then disabled  
 Max. retry on error: 4  
 SMS header: 120 character

- **SMS forwarding** to one of the 8 telephone numbers. Attention! Never select the phone number of the module!
- Here you can also save **SMS programming security code**.
- **Daily SMS limit**: it can be set how many SMSs can the module send a day. This function can be switched off by entering 255. **If you set this value to 0 module will not send SMS!**
- **Maximum number of attempts** can also be set when there is an SMS sending failure.
- **Forwarding SMS** arriving to the module to numbers to notify. (SMS command: 1234 REDIR=1...8)
- **SMS header**, that will appear before every SMS message

## Programming with Android based mobile phone



### Starting the program

After program installation it can be started with the *AndroRead* icon from the menu.

When installing the application installation from untrusted sources has to be enabled.

This can be done by checking Settings → Applications → Untrusted sources.

This function blocks installations of applications that are not from official sources (not installed from Google Play). Check if your phone is Bluetooth enabled.

After starting AndroRead it will ask for switching Bluetooth on if it was previously off. If this demand is rejected the program exits due to the missing connection link.

### Connecting to the module

By tapping the **Connect to a Bluetooth programmer** button you can choose the programmer you would like to connect to.

*It sees only that programmer that was formerly attached to the module.*

After choosing device a status line runs while the program reads out actual module settings and state.

When connection is successful main module settings can be read out.

- Connected device (usually GSM programmer)
- Type
- Firmware version
- Boot version

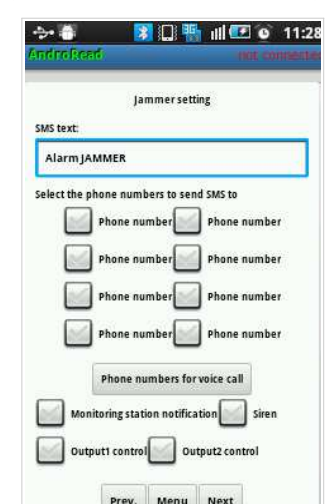



### The menu tree

In the program header the status changes to *Connected: GSM programmer* (name of the connected device).

On this tab the module settings can be refreshed with the *Setting Status* button.

By tapping the *Menu* first navigation menu can be reached. The settings saving and loading can be achieved by tapping the *Save* and *Open* buttons.

On the first page inputs, outputs, tamper, life sign, power supply monitor, open/close, jammer, incoming calls and the *Other* tab settings can be altered.

By tapping next button the second navigation menu can be reached. Here the GPRS, remote surveillance, Contact ID and line simulation values can be altered.



## Programming with SMS commands

Module can also be programmed by SMS commands. SMS starts always with the security code that can be modified whenever you want. Commands can be piled but the SMS length must be under 160 characters.

The module (if it is possible) will send reply SMS after every message. You can switch this off with **NO SMS** command or with the **RECALL** command when the module makes a call to confirm the successful programming.

Command criteria:

- can not contain accented characters
- command characters are capitals
- commands have to be separated with space
- besides = you can also use #.
- messages have to start with security code that is followed by first command without space
- SMS text command has to end with # character

Description	SMS command	x	x value	=	value after = sign	Example
editing SMS security code	CODE			=	new security code	<b>1234CODE=4321</b>
adjust clock	CLOCK			=	yymmddhhmm yy: year, mm: month dd: day, hh: hour mm: minute	1234CLOCK=1401200922 Date will be: 2014.01.20 09:22
save telephone number for caller identification	ADD			=	telephone number (with +36)	<b>1234ADD=+36305551234</b>
removing telephone number from caller number identification list	DEL			=	telephone number (with +36)	<b>1234DEL=+36305551234</b>
saving/editing telephone number for notification	TEL	x	telephone ordinal number from 1 to 8	=	telephone number (with +36)	<b>1234TEL1=+36305551234</b>
input setup	INPUT	x	input ordinal number	=	tnneeeeeeee t:0 → switched off, 1→24 h normal, 2→ backup; 3→ normal alarm 4→ delayed alarm nn→ NO or NC eeeeee.: Other parameters: 1.e=1→ send SMS of status reversion 2.e=0→ compulsory 0 3.e=1→siren sound 4.e=1→voice message 5.e=1→remote surveillance 6.e=1→ no need to pickup when calling 7.e=1→DTMF confirmation (#) 8.e=0→ compulsory 0	<b>1234INPUT1=INC00100000</b> First input is: -24 h normal -Normal Close - not sending SMS when reverts back to initial state - plays siren sound when calling - no voice message - no remote surveillance notification - when calling must be picked up -no need for DTMF confirmation

Output setting	OUTCONF	x	output serial	=	iiiiirhn iiii→if 00000 then it will be bistable, otherwise it is the duration of control in seconds r→ controlled when alarm h→controlled when call n→=1→ without caller identification	<b>1234OUTCONF=00003110</b> output is in 3 seconds monostable mode, it can be controlled by call and alarm and number identification is a must during a call
Life sign sending	LIFETEST			=	cccsstttttt ccc→cycle time, how often to send message (ex.:030 days) ss→on the given day at what time (ex.: at 12 o'clock) ttttttt→ which telephone number to choose from the 8 ex.: 00100000→3 <sup>rd</sup> phone number, 01010000→2 <sup>nd</sup> and 4 <sup>th</sup> etc.)	<b>1234LIFETEST=0071100100100</b> -in 7 days -at 11 a.m. -sending to 3 <sup>rd</sup> and 6 <sup>th</sup> telephone number
Setting up notification sending	SEND	x	1.: 1 <sup>st</sup> input 2.: 2 <sup>nd</sup> input 3.: 3 <sup>rd</sup> input 4.: 4 <sup>th</sup> input 9.: tamper 10.: power source monitor 12.: life sign	=	ssssssssvvvvvvv ssssssss→ selecting phone numbers for SMS notification (0 or 1) vvvvvvv→selecting phone numbers for call (0 or 1)	1234SEND2=0010000011110000
	SMSTEXT	x	1.: 1 <sup>st</sup> input 2.: 2 <sup>nd</sup> input 3.: 3 <sup>rd</sup> input 4.: 4 <sup>th</sup> input 9.: tamper 10.: power source monitor 12.: life sign 16.: reverting text	=	SMS text ending with *. Text must not contain accented character!	1234SMSTEXT1= alarm text*
Forwarding inbound SMSs	REDIR			=	phone number serial from 1 to 8	1234REDIR=2
Setting ringing time	RINGTIME			=	from 001 to 255 (in seconds)	1234RINGTIME=030 rings for 30 seconds
Requesting module status information	INFO				Command	1234INFO
no SMS after SMS programming	NOSMS				Command	1234command1 command 2 ... NO SMS
output control	OUT	x	output numbers	=	ON→switch on OFF→switch off RUN→controlling according to settings sssss→ controls the output for a limited time (in seconds)	1234OUT1=ON Output 1 switches on 1234OUT2=OFF Output2 switches off 1234OUT3=RUN Controlling output 3 1234OUT4=00003 Output 3 switches on for 3 seconds
Restarting module	RESTART				Command	1234RESTART

**SMS command examples:**

1<sup>st</sup> message: input setup and selecting 3<sup>rd</sup> telephone number for notification. Sending SMS and voice message to the 3<sup>rd</sup> number.

**5384TEL3=+36201255335 CLOCK=1401200922 INPUT2=4NO00100000 SEND2=0010000000100000**

SMS text is the following:

**5348** → SMS security code, every new SMS can be started with this code (to change it use the CODE command. Default

code: 1234)

**TEL3**==>changing 3<sup>rd</sup> telephone number for notification. Give the number in international format.

**CLOCK**= change the date to the following: 2014.01.20 09:22

**INPUT2**==> setting 2<sup>nd</sup> input to the following: delayed normal open input that sends siren alarm when there is an event.

**SEND2**==>second input sends SMS and voice message to the 3<sup>rd</sup> telephone number

2<sup>nd</sup> message:

- to modify the SMS text of the second input
- output and life sign message setup and
- saving an output controlling number for controlling
- finally modify the SMS security code

**5384=SMSTEXT2=second input alarm" OUTCONF1=00003010 ADD=+36705553456**

**LIFETEST=007123000100000 CODE=2345**

**SMSTEXT2**==>modify SMS text of second input. No accented characters!

**OUTCONF1**==> output setup: monostable for 3 seconds with caller identification

**ADD**==>Adding telephone number to caller identification

**LIFETEST**==>sending life sign weekly at 12:30 to the 3<sup>rd</sup> telephone number



Az 1999/5/EC számú európai irányelv  
szerint kijelölt magyar tanúsító (1413)

*Hungarian Notified Body (1413)  
according to 1999/5/EC Directive*

## Tanúsítvány

*EC Certificate of Conformity*

**Tanúsítvány száma: B-12-095-TAN**

*Certificate Number: B-12-095-TAN*

**Kelt: Budaörs, 2012. március 7.**

*Date: Hungary, Budaörs, 7th of March, 2012*

**Jogosult felhasználó: TellSystem Communication Kft.** (2040 Budaörs, Károly Király út 90.)

*Certificate Holder: TellSystemCommunication Ltd. (Hungary, H-2040 Budaörs, Károly Király str. 90.)*

### A termék megnevezése és rendeltetése:

*Type and description of apparatus*

**ProLine GSM**

*ProLine GSM*

**GSM átjelző Simcom SIM900 GSM modulal**

*GSM Data Transmitters using Simcom SIM900 GSM module*

### A MATRIX\*

a rádióberendezésekről és az elektronikus hírközlő végberendezésekről, valamint  
megfelelőségük kölcsönös elismeréséről szóló 5/2004. (IV.13.) IHM rendelet (4.  
számú melléklet) megfelelés-vizsgálati eljárása alapján tanúsítja, hogy a  
készüléktípus

**megfelel\*\***

- a 2003. évi C. törvény 80. § (1) bekezdésben az EMC előírásokra, továbbá a (2)  
bekezdés előírásaira vonatkozóan az alábbi normatív dokumentum(ok)ban foglalt  
követelményeknek:

*MATRIX certifies according to Annex 4 of the "Ministerial Decree on radio equipment and telecommunications terminal equipment and the mutual recognition of their conformity" as Hungarian transposition of 1999/5/EC Directive the apparatus is conform with the Article 3.1. (b) and 3.2. of the Directive according to the normative documentations listed below:*

**A MET Laboratories Inc. (tanúsító száma: 0980) által, az EMC28544 regisztrációs számon kiadott**

**Tanúsítványa alapján:**

*Based on the Certificate registered EMC28544, issued by MET Laboratories Inc, notified body 0980:*

**EN 301 511 v9.0.2 (03/2003)**

**EN 301 489-1 v.1.8.1 (04/2008)**

**EN 301 489-7 v.1.3.1 (11/2005)**

**EN 60950-1:2006+A11:2009**

E Tanúsítvány kiállításával egy időben MATRIX a minősített készüléket a következő  
azonosítószámmal lajstromba vette:

*Issuing this Certification of Conformity MATRIX registered this apparatus by identification number:*

**12-095**

A gyártó (forgalomba hozó, importőr) a minősített készüléken – a készülékre vonatkozó minden  
követelmény teljesülése esetén – az alábbi megfelelési jelet kötelese feltüntetni:

*The apparatus should be marked by the manufacturer (importer), if it fulfils all relevant requirements, with*

**CE1413**

továbbá jogosult a MATRIX tanúsító védjegyének használatára.

*furthermore the manufacturer is entitled to use the trade-mark of MATRIX.*

  
**tanúsítási igazgató**  
*Director of Certification*

  
**ügyvezető igazgató**  
*Managing Director*

*\*\*A MATRIX Kft. a 004/2008/2M. számú Kijelölési Okiratban a közlekedési, hírközlési és energiaügyi miniszter által kijelölt tanúsító szervezet  
MATRIX is designated by Hungarian transport telecommunications and energy-supply minister in Charter of Appointment No. 004/2008/2M.*

*\*\* A mérések során alkalmazott beállítások esetén (dedikált antenna, szoftverbeállítások, hardver konstrukció)  
As arranged during measurement (dedicated antenna, software settings, hardware construction)*